

Harmonics and Resonance Issues in Wind Power Plants

IEEE PES Wind Plant Collector System Design Working Group

Contributing Members: M. Bradt, B. Badrzadeh, E. Camm, D. Mueller, J. Schoene, T. Siebert, T. Smith, M. Starke, R. Walling

Abstract—This paper presents a summary of the most important issues with respect to harmonics and resonances within wind power plants. An introduction is given to provide an overview of the various power quality related issues encountered when designing, commissioning, or operating a wind power plant, as well as typical characteristics of the components associated with wind power plants. The many variables, which influence harmonics and resonance in wind power plants, will be described with respect to analysis methods, avoidance, mitigation, and compliance with IEEE Std 519-1992 recommended practices.

Index Terms— Power system harmonics, wind power plants, wind turbines, harmonic penetration, harmonic impedance scan, system resonances, harmonic compliance, harmonic filters.

List of Acronyms—

CP	Cumulative Probability
CP95%	CP 95% Level
DFIG	Doubly Fed Induction Generator
EMT	Electromagnetic Transients
HVDC	High Voltage Direct Current
LGIA	Large Generator Interconnection Agreement
PCC	Point of Common Coupling
RLC	Resistor-Inductor-Capacitor
STATCOM	Static Compensator
SVC	Static Var Compensator
TDD	Total Demand Distortion
THD	Total Harmonic Distortion
UWIG	Utility Wind Integration Group
VSC	Voltage Source Converter
WTG	Wind Turbine Generator
WPP	Wind Power Plant

I. INTRODUCTION

The ideal electrical system sinusoidal waveform is pure, continuous, and of a constant fundamental frequency. Power quality issues are a deviation from this ideal system waveform, and limits have been adopted through various standards and guidelines for maintaining continuity, voltage magnitude, harmonic limits, and transient nature of electric power systems. Two of the most common power quality issues encountered within wind power plants are harmonic resonance and voltage flicker.

Flicker is a variation in the system ac voltage, which can result in observable changes in light output and in some cases become annoying and objectionable. In wind farms flicker is caused by variations in wind turbine generator (WTG) power output due to variation in wind speed, blade pitching, tower shadowing, wind shear or gradient, and WTG start and stop operations. Flicker is usually a concern for interconnections to “weak” systems, such as distribution interconnections in areas of the system where fault currents are very low. The

Utility Wind Integration Group (UWIG) has documented this phenomenon very well [1] and it will therefore not be further addressed in this paper.

Resonance issues arise in wind power plants because wind power plants contain both inductive source characteristics and capacitive elements. Wind power plants typically consist of an interconnection substation which transforms from high to medium voltage, several medium voltage underground cable collector system circuits, reactive compensation equipment, wind turbine transformation from medium to low voltage, and wind turbine generators with internal power factor correction capacitors or dynamic power controllers which can also absorb or contribute reactive power. Wind power plants typically have vast underground cable systems, which can result into many series and parallel resonance points. Resonance conditions can be located using frequency domain analysis of impedances and/or amplification factors, recognizing that peaks and valleys of the frequency scan represent parallel and series resonances, respectively.

Feeder line and cable capacitance and the substation reactive compensation equipment, such as medium voltage switched or fixed shunt capacitor banks, can create significant parallel resonance interaction with the main transformer and any associated load tap changing apparatus. Due to the many steps of shunt capacitor steps within the substation capacitor banks, parallel resonance between adjacent capacitors must not be overlooked.

Harmonic sources can be comprised of power system background levels of harmonics and WTGs. One or both of these sources inject harmonic currents that have to be considered when assessing voltage and current distortion compliance requirements.

There are two primary methods for controlling harmonics impacts in wind power plants. (1) The method of avoidance during the design process of the wind plant collector system allows for careful consideration of equipment to prevent resonance problems. (2) Designing harmonic filters based on measurements and simulation results in order to reduce or control series resonance conditions of the wind plant. The later method is the most common mitigation approach, when capacitive compensation is required.

II. RESONANCE AND FREQUENCY CONSIDERATIONS

One objective of a harmonic analysis is to characterize the potential of the wind collector system for series and parallel resonance conditions. Series resonance problems are characterized by series inductance and capacitance driven by background harmonic voltages from the grid (see Fig. 1). Series resonance points are identified by dips in the frequency scan

Please see reference [11] for a discussion of WTG types.

on the high side of the interconnect transformer. The relatively small impedances at the series resonance points can result in high harmonic currents.

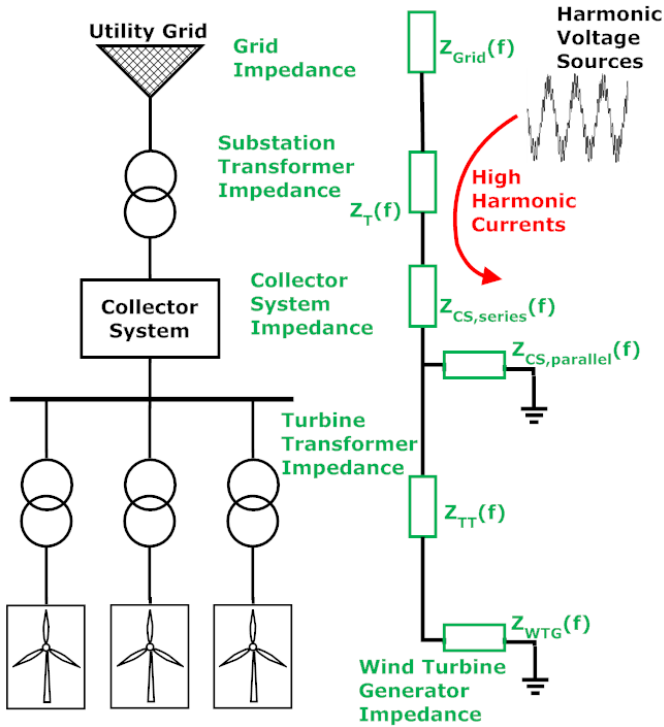

Fig. 1. Illustration of series resonance in a wind power plant

Parallel resonance points magnify voltages and are identified by peaks in the driving point impedance on the medium voltage side of the transformer (Fig. 2). Parallel resonance concerns occur when WTG harmonic current sources excite resonant points (relatively high impedances) resulting in significant harmonic voltages.

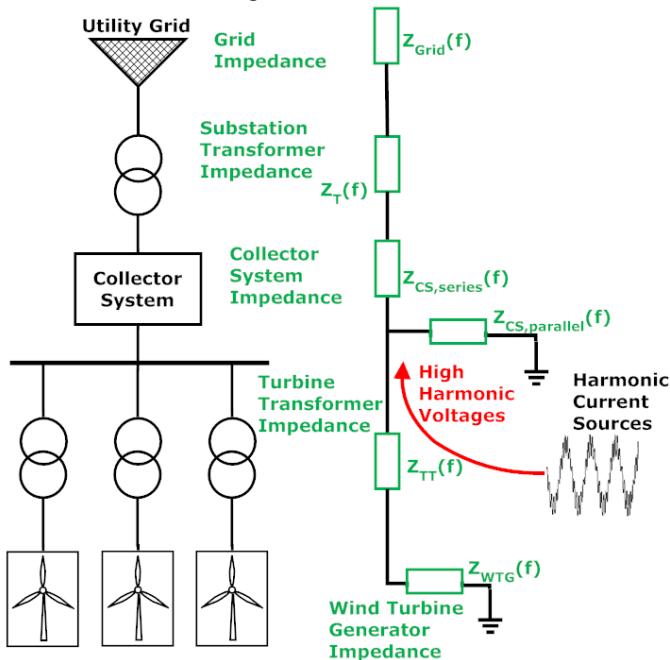

Fig. 2. Illustration of parallel resonance in a wind power plant

When dealing with parallel operation of two wind power plants located within close proximity, it is necessary to also avoid resonance conditions between the two plants and the associated shunt capacitor banks.

A. Frequency Scan Analysis

Frequency scan analysis is a characterization of the system equivalent impedance at a bus in the system as a function of frequency. Figure 3 provides an example of a frequency scan at the main 34.5 kV wind plant bus with over 50 turbines and 30 miles of underground collector cable. In the case where all of the turbines are in operation, the parallel resonance of this example system was near the 10th harmonic frequency (600 Hz).

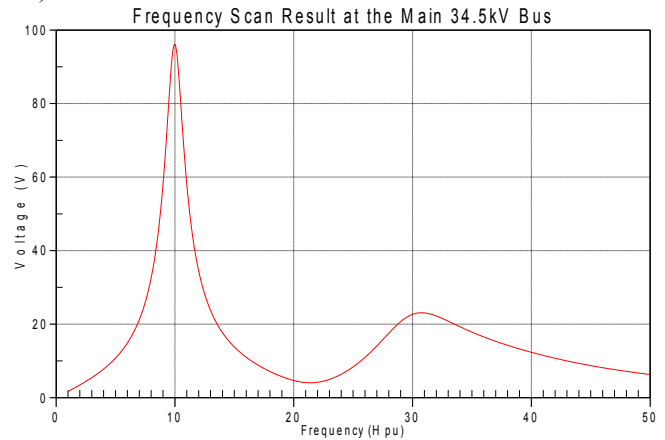

Fig. 3. Example graph of frequency scan results

Frequency scans are performed by system modeling software that injects 1 A sinusoidal currents. The frequencies of the injected currents range from the fundamental frequency (60 Hz for this particular example) up to the largest harmonic frequency of interest to determine the resulting system voltage. In this case the output can alternatively be presented as impedance in Ohms. Often frequency scans are done at various grid locations or at the 34.5 kV collector bus.

An important consideration is that the magnitudes of the frequency scans do not determine the severity of the problem by itself. For harmonic problems, there must also be a sufficient level of harmonic source voltages or currents at or near the resonant frequency to excite the resonance. There is no firm threshold separating impedance magnitudes that might cause trouble, from those that do not cause trouble. A detailed harmonic analysis using harmonic sources specified by measured data and/or turbine manufacturer-provided data is necessary to quantitatively assess potential problems.

A major challenge in assessing the potential for harmonic problems is to cover the large number of different system configurations that can occur during normal operation of the wind plant. The impedance of the system, which can vary significantly, determines the resonance points. Impedance variations are caused by (1) the number of wind turbines in operation, (2) switching of capacitor banks located at the substation, (3) tur-

bine power factor correction capacitors (commonly used in Type 1 and Type 2 turbines), and (4) variations in grid harmonic impedance. In practice, one option to analyze this large number of configurations is using automation to run a frequency scan for various configurations and to display the results in a contour plot.

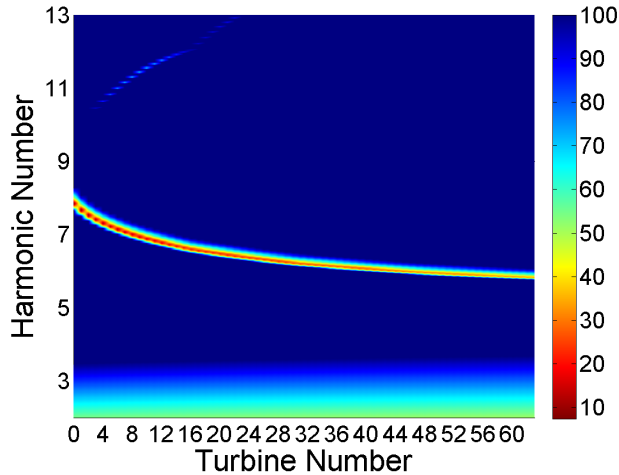

Fig. 4. Contour plot of the driving point series impedance for a large number of system configurations

As an example, Fig.4 shows a contour plot of the driving point series impedance for a large number of system configurations. The harmonic order is displayed on the Y-axis, the number of turbines on line is displayed on the X-axis, and the scale on the right displays the impedance magnitude. A low impedance indicates a potentially hazardous series resonance point. The example contour plot displays results of over 60 simulation runs (one simulation for each turbine number). The contour plot shows that the only odd harmonic frequency for which series resonance points exist is the seventh harmonic. Note that the capacitances of the substation capacitor bank and the turbine power factor correction capacitors were fixed in all simulation runs summarized in the contour plot. Similar contour plots can be created for different system configurations. Furthermore, similar contour plots can be created to determine parallel impedance resonance points.

B. Source Characteristics of Wind Turbine Generators

The frequency scan results for a wind plant collector system are dependent on the type of wind turbine and its representation in the harmonic model. Figure 5 shows an example implementation of a Type 3 (DFIG) turbine for a harmonic study. For both Types 3 and 4 (Full Conversion) turbines, it is important that the high frequency harmonic filters are not overlooked. These filters are often installed on the line side of the voltage source converter (VSC) to shunt the energy from the switching frequency. Even though these filters may only be rated about 50 kvar per turbine, the accumulation of filters for many turbines will shift the natural resonance of the system. Figure 6 provides an example of the effects from these filters.

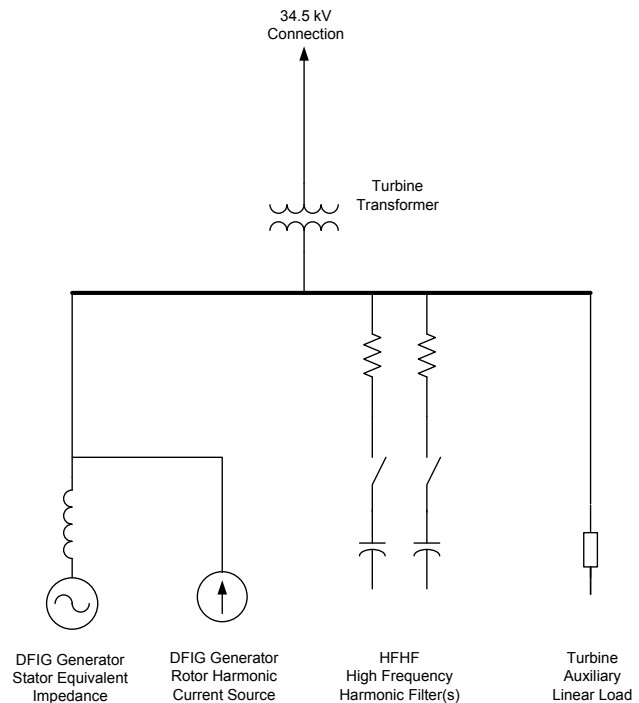

Fig. 5. One-line diagram depicting a Type 3 (DFIG) turbine harmonic model

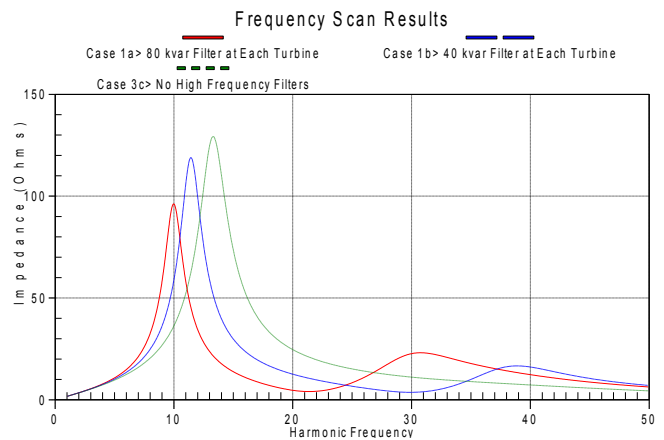

Fig. 6. Frequency scan results showing the impact of turbine high frequency harmonic filters

The typical harmonic analysis practice used in the industry is to consider harmonic-generating devices as ideal current sources. The current injected by an ideal current source is invariant with the driving point impedance of the system to which it is connected, and also invariant regardless of the existence of other sources of harmonic distortion in the grid. When analyzing the influence of other sources, such as background grid voltage distortion, a wind turbine modeled in this way would be considered an open circuit.

Actual harmonic performance of wind plants can differ substantially from the performance predicted by the classical approach. This harmonic analysis practice evolved at a time when the dominant harmonic sources were load-commutated converters and diode rectifiers. For these devices, a constant

current assumption has been traditionally used as a reasonable simplification. It has been, however, reported [2] [3] that the harmonic impedances of the current source HVDC converters can affect system resonances, and ignoring them can lead to excessively high harmonic voltage distortion and ineffective harmonic filter designs. The main reason for the oversimplification is the inability of present commercial programs to model the effective converter impedances.

Most wind turbines use a VSC, which have very low harmonic impedance, compared to a current sourced converter. Despite having low harmonic impedance, representation of the VSC by an ideal current source may have considerable inaccuracy, which can lead to misleading results. This is because in reality the harmonic current of VSC will not remain constant, and varies depending on the converter control.

A voltage source converter is better characterized as a Norton equivalent source [4]. The equivalent shunt impedance has real and reactive components that vary by frequency, and phase sequence, in a complex manner defined by the converter's controls as well as the parameters of the converter's physical components. The impact of the source shunt impedance can be very significant, as the magnitude can be a few tenths of the wind turbine's base impedance. As a result, the harmonic current of a wind turbine can vary over a very wide range for the typical range of driving point impedances defined by the collector system and grid characteristics.

Typically, wind turbine generator manufacturers provide test data, defined in terms of current injection, demonstrating compliance with power quality standards and assessing characteristics at the turbine terminals [5]. It should be noted that it is not feasible for a manufacturer to certify compliance at the point of grid interconnection, because the collector system and the particular grid affect the currents at that location. These test data are influenced by the characteristics of the system in which the tests are conducted, both in terms of impedance and in terms of ambient voltage distortion. It is highly difficult to find a test location free of ambient harmonics, and it is also difficult to segregate harmonic current flow caused by the wind turbines and flow caused by grid distortion driving current into the wind turbines and wind plant shunt capacitances. Information on the equivalent source impedance of wind turbines is generally not available.

Modeling the source characteristics of wind turbines is more complex than was initially considered, certainly requiring more complexity than the harmonic current source models used for industrial studies. Practices are still evolving to more sophisticated representations for the WTG harmonic source characteristics. Measurements continue to be an important part of the validation process for harmonics studies, as experience from the field provides a better understanding of what level of detail is necessary in the system modeling.

C. Source Characteristics of Utility Interconnection

The utility grid is characterized by two categories of parameters: The first category is the background, or ambient,

voltage distortion present at the point of interconnection without the wind plant connected. The second is the driving-point impedance of the grid at harmonic frequencies.

1) Ambient Voltage Distortion

Ambient harmonic voltage distortion is characterized in terms of the voltage magnitude by harmonic order. This distortion tends to vary over time, due to variations in the harmonic current injected by sources distributed throughout the grid, and also due to variations in the transmission system resonant characteristics, which can amplify distortion at a particular location. Because of the variability in ambient distortion, data used for wind plant harmonic analysis may be statistically characterized. This will allow the plant design to be made on the basis of the appropriate degree of conservatism.

The interconnection utility may have records of compliance with IEEE Std 519-1992 [6] and other power quality standards in regards to power quality limits for their transmission system in general. Availability of ambient voltage distortion characteristics for the particular point of proposed wind plant interconnection, however, is typically not available. This voltage distortion may be characterized with access to operational utility electrical system data from planning, protection, and system operations.

More accurate characterization of ambient voltage distortion levels may require installation of harmonic monitoring equipment at the proposed interconnection point, for an extended period of time.

If the ambient voltage distortion is not available and a harmonic study is being performed the voltage distortion limits contained in Table 11.1 of IEEE Std 519 can be used as a reference for interconnection bus voltage ambient conditions. However, it should be realized that actual distortion might exceed IEEE Std 519 limits. It should also be realized that applying each of the individual harmonic limits collectively might yield unrealistic results. The value of the actual individual frequencies modeled might depend upon local conditions such as other harmonic sources in the area. Some utilities may also provide a planning limit that can be used for studies.

2) Transmission System Harmonic Impedance

Proper representation of the transmission system's impedance at harmonic frequencies is important for both analysis of harmonic currents produced by the wind plant, and interaction of the wind plant with ambient grid distortion.

There are grid representation practices in use for wind plant harmonic studies, which are often less than adequate. Sometimes, the impedance of the transmission system is ignored altogether by assuming the point of interconnection to be an infinite bus or as an ideal voltage source representing ambient voltage distortion. While this simplification is reasonably adequate when the wind plant is small, and connected to a very stiff transmission system, it is not adequate in general.

Another practice is to define the grid impedance as an inductance and resistance defined by the fundamental-frequency

short-circuit impedance. This is reasonably accurate for frequencies below the first resonance of the transmission system. Transmission systems, however, often have resonances in the same range of frequencies as the harmonics of greatest interest (i.e., 5th and 7th).

Determination of the harmonic impedance of the transmission system requires detailed modeling. The extent of the transmission system, which must be discretely modeled, depends on the frequency range of most interest, and the required degree of accuracy. Modeling in the lower order harmonic range (e.g., 3rd, 5th, 7th) requires a more extensive transmission model than that needed for similar accuracy in analysis of higher-order harmonics. For a small wind plant in a stiff transmission system, the sensitivity of results to the grid impedance representation is less significant, and thus a less extensive transmission model can be justified.

If a load flow model or a short circuit model, of the transmission system is available, then it is often possible to convert these large models into an electro-magnetic transient (EMT) model or harmonics model using data conversion utilities. The use of an EMT type or harmonic programs allows calculation of the frequency and impedance of each network resonance point.

Harmonic impedance analysis requires that the frequency-dependent characteristics of the external grid components be accurately represented. Damping is an important determinant of resonance severity, and proper representation of grid component damping at harmonic frequencies is essential. For example, a transformer is represented in fundamental-frequency studies as a series inductance and resistance. Such a model, if used for harmonic analysis, would exhibit an X/R ratio that would monotonically increase with increasing frequency, without bound. In reality, a transformer reaches its maximum X/R at a frequency of one or two hundred Hertz, and the X/R decreases continuously for higher frequencies. Thus, the simplified series resistance-inductance representation is clearly inadequate for harmonic analysis. Proper harmonic analysis requires that a model which properly represents damping of transformers and other components be used. Sufficiently accurate models of the network components for harmonic analysis are discussed in [7].

The harmonic impedance of a transmission system can be highly dependent on the specific system configuration. Outages of lines and transformers, even ones that are moderately distant from the point of wind plant interconnection, can significantly change the impedance at certain harmonics. In addition to such contingencies, routine system variations such as the status of capacitor banks and generating unit commitment can also have a large impact. Thus, the transmission system impedance cannot be considered as a single value for each harmonic. The impedance varies over a range in the R-X plane, depending on system condition. Figure 7 illustrates the rather wide range of harmonic impedance and impedance angle for an actual transmission system, over the range of ordinary contingencies and operating conditions. Thorough har-

monic analysis of wind plant harmonic performance requires consideration of every possible transmission system impedance. Studies to define transmission system impedance need to consider the range of normal and contingency system conditions. This may result in a large number of possible impedance values to be considered.

To make harmonic analysis manageable, boundaries of the harmonic impedance ranges can be defined as a shape, such as a pie-shaped sector or polygon, in the R-X plane. Figure 8 illustrates a pie-shaped sector, defined by a minimum and maximum impedance magnitude, and a minimum and maximum impedance angle. Critical resonance conditions will always fall on the boundaries of such a shape that surrounds all actual harmonic impedance loci. The application of shapes to define grid harmonic impedance range is a routine practice in transmission technologies where harmonic performance is critical (e.g., HVDC). Some European transmission system operators provide similar harmonic impedance envelopes. This is usually provided separately for the 2nd-5th harmonics and for the 6th and higher order harmonics. For the 2nd-5th harmonics the impedance plot is defined as a square bounded to the area between R_{min} - R_{max} and X_{max} - X_{min} . For the 6th and higher order harmonics the envelope consists of a semicircle with its radius in the origin, and a square to the right of the semicircle.

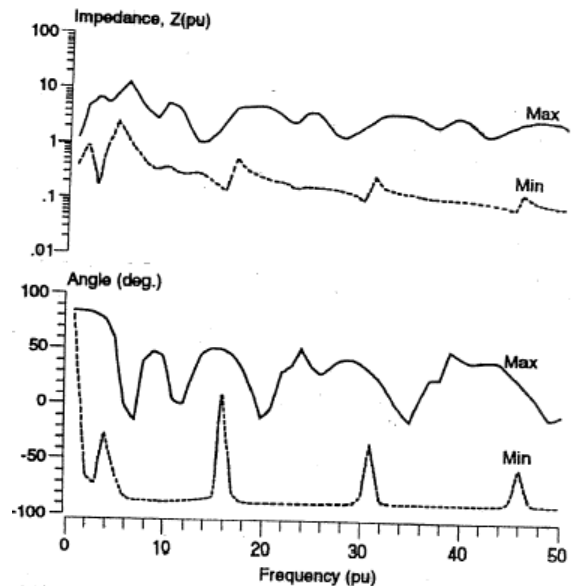

Fig. 7. Range of harmonic impedance at a typical point of interconnection

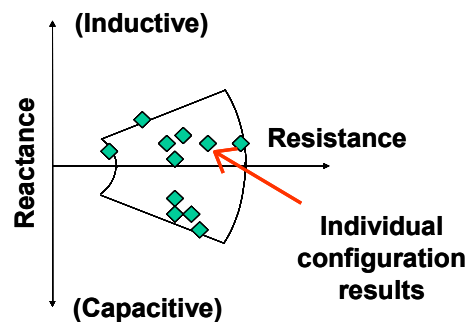

Fig. 8. Harmonic impedance range defined as a sector

Caution and discretion needs to be applied when using harmonic impedance ranges in studies of ambient transmission distortion amplification within wind plants. Ambient voltage distortion, applied as a voltage source behind the transmission system impedance, is usually defined as a maximum, or a range of values, determined from monitoring. High values of ambient distortion may be the result of resonant conditions in the transmission system, that would tend to have a high source impedance. The harmonic impedance range, however, may include low impedance values that are the result of other conditions. The impedance value range is usually defined by system harmonic analysis studies that are performed independent of monitoring used to define ambient voltage distortion magnitude. The correlation between particular background distortion values and particular impedance values is thus not generally known. Use of the highest magnitude ambient voltage distortion combined with a source impedance that results in a worst-case resonance within the wind plant is conservative, but also potentially conservative to an excess degree.

3) Representation of Reactive Compensation Equipment

The representation of the reactive compensation equipment is dependent upon the actual equipment used. If mechanically-switched capacitors and reactors only, these components would typically be represented as single lumped equivalent capacitor or reactor for each bank and various combinations being energized considered in the resonance and distortion analysis. If inverter-based dynamic compensators with mechanically-switched capacitors and reactors are applied, the representation would be expanded to include an equivalent for the step-up transformers and an equivalent ac filter associated with the inverters. The harmonic current contribution of the inverter-based dynamic compensator is negligible in the range of frequencies of interest due to the high modulation frequency typically used. Furthermore, the ‘side lobes’ of the very high modulation frequency is filtered through the ac filter at the inverter terminals before reaching the MV system. If static var compensators (SVCs) are used, the representation will include the lumped equivalents of the capacitor, filter, and reactor banks, as well as an equivalent current injection source. A STATic COMPensator (STATCOM) is comprised of a voltage source converter, and as per the discussions made earlier, can be represented by its Norton equivalent circuit.

III. COMPLIANCE WITH POWER QUALITY STANDARDS

In the United States, IEEE Std 519 is the most common industry standard for power quality governing wind power plants although certain limitations apply. Article 9.7.6 of the Standard Large Generator Interconnection Agreement (LGIA), used by many electric reliability organizations, requires generating facilities to limit excessive harmonic distortion in accordance with IEEE Std 519. The application of the IEEE Std 519 limits to wind plants is an area of practice that is evolving. Fundamentally, it is important to realize that the current limits in the recommended practice do not apply to harmonic cur-

rents that are absorbed by the wind plant from the background harmonic source of the grid. Series resonance from the collector cable capacitance can easily result in an idle wind power plant absorbing more harmonic current than prescribed by the IEEE Std 519 recommended limits.

Facility compliance is evaluated at the point of common coupling (PCC), and although individual wind turbines may be certified as IEEE Std 519 compliant, the aggregate facility may not meet emission limits. Section 10 of IEEE Std 519 outlines the current distortion limits for individual and total harmonics for various grid voltages as a function of a facilities ratio of short circuit current to the maximum fundamental load current. The current distortion is based upon the maximum demand load current (fundamental frequency). This percentage calculation is referred to as the Total Demand Distortion (TDD). It is often convenient to convert the current limits from percentage values to Amperes, allowing direct comparison with measured values. An example of harmonic current limits at a wind power plant (WPP) is given in Table I.

TABLE I
HARMONIC CURRENT LIMITS AT A WPP INTERCONNECTION

Example Wind Power Plant						
Primary Current IL						
102.8 MVA						
345 kV						
172.0 Amps						
IEEE 519 (1992) Table 10-5 -- Current Distortion Limits for General Transmission Systems >161kV						
Limits (Percent)	<11	11=<h<17	17=<h<23	23=<h<35	35=<h	TDD
	2.0%	1.0%	0.75%	0.3%	0.15%	2.5%
Limits (Primary Current Amps)	3.4	1.7	1.3	0.5	0.3	4.3

The maximum current harmonics for interconnecting distributed resources with electric power systems are given in IEEE Std 1547 [8]. The limits indicated for distributed resources are the same as those for large loads specified in IEEE Std 519.

IEC 61000-4-30 [9] prescribes a standard approach for measuring harmonics, where 200 ms windows are used. The data are then aggregated into 10 minute intervals. The 10 minute average values should be used for comparison against the recommended limits. An example trend of the 5th harmonic current at the point of interconnection is given in Fig. 9.

Additionally, voltage distortion limits are also set forth in Table 11.1 of IEEE Std 519 for the corresponding interconnection bus voltage. However, some sites will have harmonic voltage background levels that will exceed these limits, even when the WPP is not in service. The actual voltage distortion contribution from the WPP may be difficult to assess, as the background and WPP harmonic generation will vary over time. The current distortion (Individual harmonics and TDD) may be the most practical measurement for compliance.

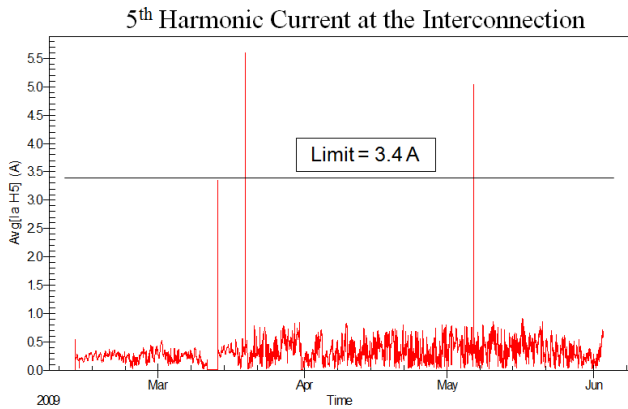

Fig. 9. Example trend showing the 5th harmonic current at a wind power plant point of interconnection (10 minute average values)

When limits are exceeded, they should be evaluated on a statistical basis. The limits should be met by the value that provides a cumulative probability level of 95%. Figure 10 shows an example case that can be considered as compliant, as the limit is met by more than 95% of the measured values. The data block in Fig. 11 (expanded in Fig. 11A), which statistically represents the same data as in the previous trend, shows that the cumulative probability 95% level (CP95%) is 1.42% V_{THD} , which meets the recommended limit.

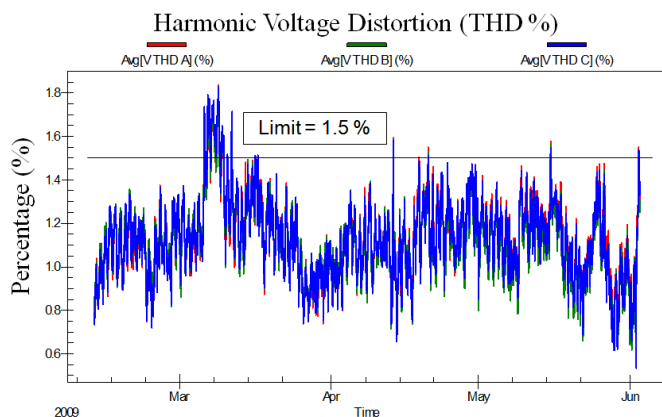

Fig. 10. Trend of the harmonic voltage distortion at a wind power plant interconnection

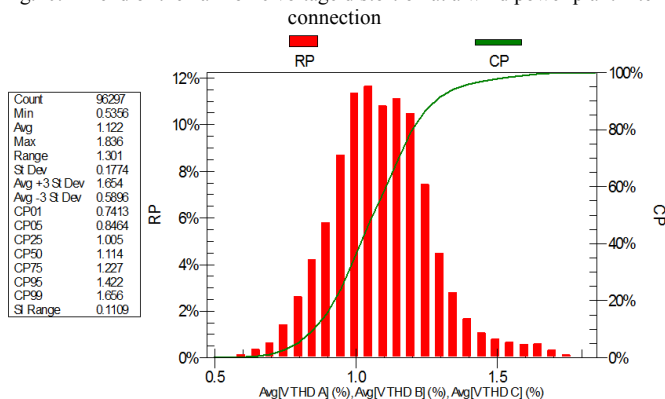

Fig. 11. Statistical analysis of harmonic voltage distortion measurements

In preconstruction, harmonic studies are often commissioned using estimates of background harmonics from the grid

and also data provided by equipment manufactures to prevent harmonic issues upon commissioning. Reasonably, it is understood that such studies will not always insure compliance. No harmonic mitigation solution is ideal for every situation and accordingly post construction harmonics monitoring may be needed to determine a viable solution should an issue arise. It should also be noted that post-commissioning harmonic measurements might be inconclusive because it is problematic to segregate harmonic currents caused by the wind plant from harmonic current flow into the plant as a result of grid voltage distortion. In the worst case, failure to comply with harmonic limits could result in a default of the terms of an LGIA, which could lead to termination of the agreement if the default is not cured.

IV. HARMONIC FILTER OVERVIEW

Harmonic filters are often used as a mitigation method for preventing unwanted harmonic contributions into a wind power plant. If the WPP includes capacitor banks for reactive power support, frequently these provisions will introduce resonance concerns. Generally, harmonic filters will address these concerns. There are many options for harmonic filter designs; two of the most prevalent methods are the passive notch filter and the band pass filter often called a C-Type harmonic filter. More details on design and performance of the harmonic filters can be found in [10].

The tuned notch type filter is implemented by placing series reactors in an existing capacitor bank, tuned to a single frequency, usually tuned below the 5th harmonic frequency. Advantages of a single tuned filter are that it is a simple design, and multiple stages of reactive power compensation can be designed identically. A disadvantage of the single-tuned filter is that it can lead to sharp resonances at non-characteristic frequencies. Figure 12 shows an example of the effect of a single-tuned filter on a system frequency response.

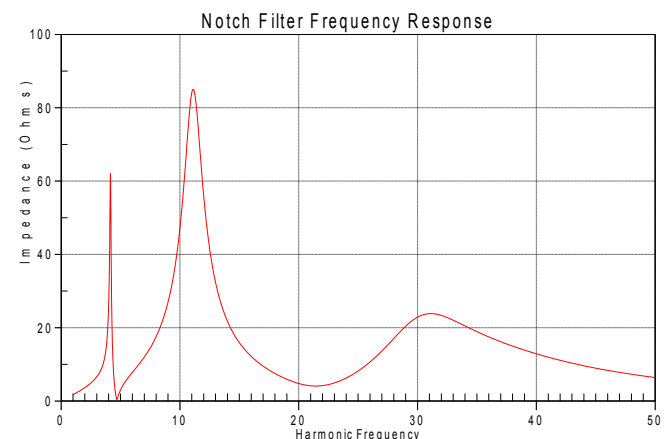

Fig. 12. Example frequency response of a single-tuned (4.7th harmonic) filter on a wind power plant 34.5 kV main bus

A C-Type filter configuration is shown in Fig. 13. It is designed so that the reactor and smaller (“c-stage”) capacitor are impedance matched, so that a minimal amount of fundamental frequency power is dissipated across the damping resistor.

While, it presents more complications for the system design and protection, it does have certain advantages. (1) It provides further system damping of unintended resonance conditions over a wide frequency range. (2) It is an excellent choice for capacitor banks installed on transmission systems, especially where there are other banks on nearby buses. (3) It can also be a good choice for 34.5 kV systems, where additional capacitor banks (for reactive power) are installed without harmonic filters.

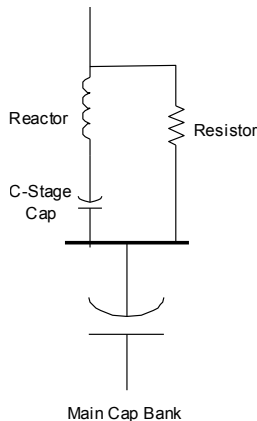

Fig. 13. Online configuration of a C-Type harmonic filter

Figure 14 shows an example of the effect of a C-Type filter on a system frequency response.

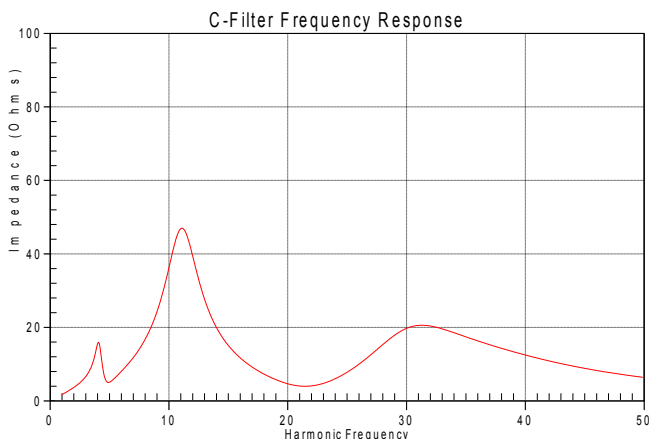

Fig. 14. Typical frequency response of a C-Type harmonic filter at a wind power plant 34.5 kV main bus

V. CONCLUSION

This paper has presented harmonics and resonance issues for wind power plants in an overview and summary fashion. This included an introduction to series and parallel resonances, frequency scan analysis, and the harmonic source characteristics of WTGs and of utility interconnections. Further, the issue of compliance with the power quality standard IEEE Std 519 was presented, as was an overview of harmonic filters.

The publication of this paper was a minor miracle. It was the result of two years of concerted effort by the authors and the IEEE PES Wind and Solar Plant Collector System Design working group--gathering information, preparing drafts, argu-

ing amongst the interested parties, restarting drafts and arguing some more, and finally coming to agreement. The authors sincerely hope that this and other working group papers are found to be valuable to those who will plan, design, analyze, construct, and operate wind power plants. Recognition is given to the authors and their employers for contributing the resources for the preparation of this work.

For more information on available materials, or to find out how to participate in this working group's activities, please see: <http://grouper.ieee.org/groups/td/wind>

VI. REFERENCES

- [1] T.E. McDermott, "Distributed Wind Evaluation Methodology," *AWEA WindPower 2009*.
- [2] J. Arrillaga, B. C. Smith, N. R. Watson, and A. R. Wood, *Power System Harmonic Analysis*. New York: Wiley, 1997.
- [3] D. L. Dickmader, S. Y. Lee, G. L. Desilets, and M. Granger, "AC/DC harmonic interactions in the presence of GIC for the Quebec-New England phase II HV dc transmission," *IEEE Trans. Power Delivery*, vol. 9, pp. 68-78, Jan. 1994.
- [4] R. C. Dugan, M. C. McGranaghan, S. Santoso, H. Wayne Beatty, *Electrical Power System Quality*, New York: McGraw-Hill, 2004.
- [5] IEC 61400-21 (2008) Wind turbines - Part 21: Measurement and assessment of power quality characteristics of grid connected wind turbines.
- [6] IEEE Std 519-1992, "Recommended Practices and Requirements for Harmonic Control in Electric Power Systems".
- [7] *IEEE Tutorial Course on Harmonic Modeling and Simulation*, Course text TP-125-0, February 1998.
- [8] IEEE 1547-2003 "Standard for Interconnecting Distributed Resources with Electric Power Systems".
- [9] IEC 61000-4-30 (2008) Electromagnetic compatibility (EMC) - Part 4-30: Testing and measurement techniques - Power quality measurement methods.
- [10] Guide to the specification and design evaluation of AC filters for HVDC systems, CIGRE Technical Brochure, WG 14.30, 1999.
- [11] Wind Plant Collector Design WG, "Characteristics of Wind Turbine Generators for Wind Power Plants," Proceedings of 2009 IEEE Power and Energy Society General Meeting, Calgary, Canada, July 2009